

INSTALLATION MANUAL

ROOM CONTROL UNIT

8 INPUT 8 OUTPUT







Model: RCU-8OUT-8IN



i PRODUCT INFORMATION

This device is used to control ON/OFF for lights and other devices, electrical locks, 3rd-party curtain motors, shutters, floor heaters, and fan coil units (FCU), and it includes 8 Digital Inputs (dry inputs) and one 0-10V dimming channel.

PRODUCT SPECIFICATIONS

| | | | |
|---|---------------------------------------|---------------------------------|--|
|  | Output switching voltage | Number of channels | 8 |
| | | Nominal voltage | 0 – 230 V AC 50/60 Hz |
|  | Output switching current | Max. switching Voltage | 440VAC / 125VDC |
| | | Analog Output | Ch8 include 0-10V output for dimming |
| | | Nominal current per channel | Ch1: 20A, Ch 2-8: 10A |
| | | Maximum total channels load | 90A |
|  | TIS Bus | Max switching current | 16A Resistive 8A florescent |
| | | Max Continues current | 10A VAC |
| | | Number of devices on 1 line | Max. 64 |
| | | Bus voltage | 12-32 V DC |
|  | Operating and display elements | Current consumption (Normal) | <30 mA / 24 V DC |
| | | Current consumption (operation) | <40 mA / 24 V DC |
| | | Protection | Reverse Polarity Protection |
| | | Programming button/LED (PRG) | For assignment of the physical address |
|  | Functions | 1-8 buttons | Manually ON/OFF and Programming |
| | | Lighting control ON/OFF Dimming | 8 channels controlled separately |
| | | Curtain control | Can set 4 group of curtains (open/close) option |
| | | Fan speed control | Can set 2 group of Fan (low, med, high) option |
| | | Dimming | Ch 8 used with 0-10V output for dimming |
| | | Scenes | 8 different scenarios |
|  | Dimensions | 8 Digital inputs | Programmable inputs to connect to normal wall switches and sensors |
| | | Width × Length × Height | 145mm × 75mm × 91mm |
|  | Housing | Materials | ABS fire proof |
| | | Casing color | Black Gray |
| | | Button color | Silver |
| | | IP rating | IP 20 |



BARCODE (UPC-A)





Read Instructions

We recommend that you read this Instruction Manual before installation.



Data Cable

Use screened stranded RS485 data cable with four twisted pairs. Configure devices in a "Daisy Chain."

Do not cut or terminate live data cables.



Safety instructions

Electrical equipment should only be installed and fitted by electrically skilled persons.

Failure to observe the instructions may cause damage to the device and other hazards.

These instructions are an integral part of the product and must remain with the end customer.



Electrical Wires

The installer should adequately consider the total current consumption when selecting the wires.

Recommended wire size for load (light channels) and input wires is 2.5 -4 mm.



Programming

This device can be tested and programmed manually. Advanced programming requires TIS Device Search software. Advanced software programming knowledge should be obtained in the advanced training courses.



Warranty

We provide a warranty as required by law. A hologram warranty seal and product serial number are provided on each device. Please send the description of the defect with Product S/N to our dealer network.



Simple Installation

DIN Rail mount facilitates installation. Fixing points are provided for installation without the use of DIN rail.



Mounting Location

Install in a dry, well-ventilated location. Controllers may emit some mechanical noises. Consider this when deciding on a mounting location.



INSTALLATION STEPS

1 Turn off the main electrical source before installation.

2 Mount the device on a DIN Rail inside an approved enclosure. The device can also be installed without the use of DIN Rail by two mounting screw holes.

3 Connect RS485 data cable to the TIS-BUS port as per the connection diagram. No need to loop the TIS-bus cable if 2 DIN Rail modules are connected together from the side bus train terminal.

4 Complete the load connection, light, floor heating, and shutter as per the following steps:



LIGHTS / APPLIANCES / FLOOR-HEATING CONNECTION

Connect the load electrical wires to outputs 1-8. Each channel can control a maximum of 10A loads. The installer should make sure not to overload the channels.

Load neutral wire should be linked to the neutral connection in DB enclosure.

WARNING! HIGH VOLTAGE

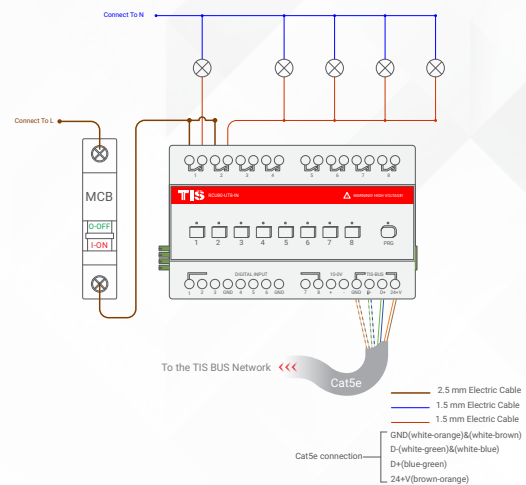
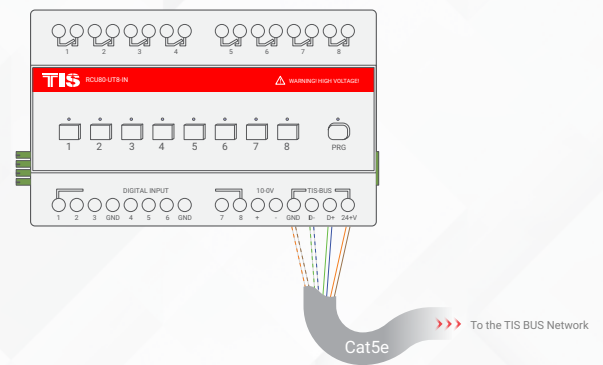
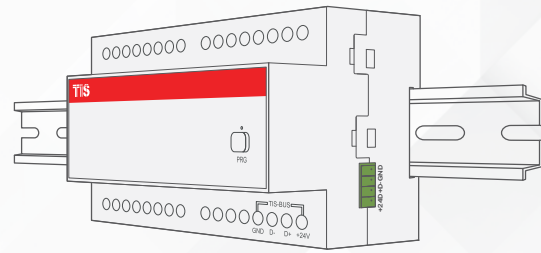

INSTALLATION STEPS



SHUTTER / CURTAIN CONNECTION

Once you combine any 2 channels as shutter/curtain, then connect the shutter-open wire to the first channel and the shutter-close wire to the second channel. The shutter neutral wire should be linked to the neutral connection in DB enclosure.



WARNING: Do not connect curtain motor wires before combining (interlocking) 2 relay channels together as curtain mode to avoid causing damage to motors. Please read about how to manually program shutter/curtain pairing in this manual.

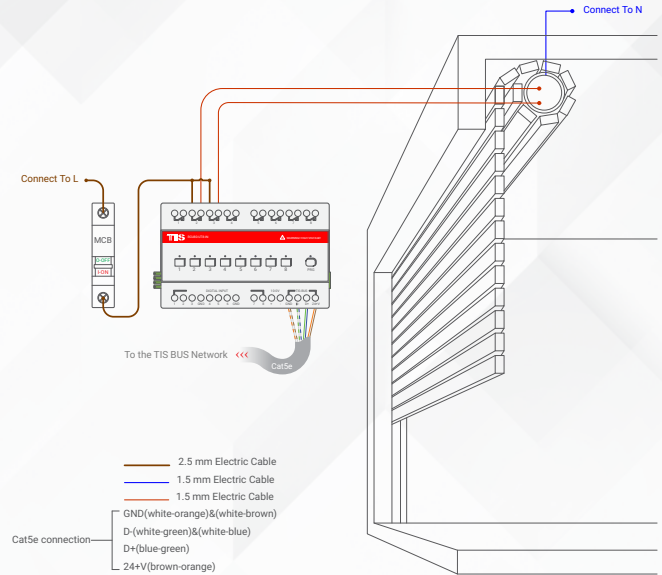

FCU Connection

Once you combine any 3 channels as FCU, then connect the FCU (Low, Medium, High) wires to the first, second, and third channels, consecutively. The FCU neutral wire should be linked to the neutral connection of the same section.



WARNING: Do not connect FCU wires before combining (interlocking) 3 relay channels together as FCU mode to avoid causing damage to FCU. Please read about how to manually program FCU pairing in this manual.

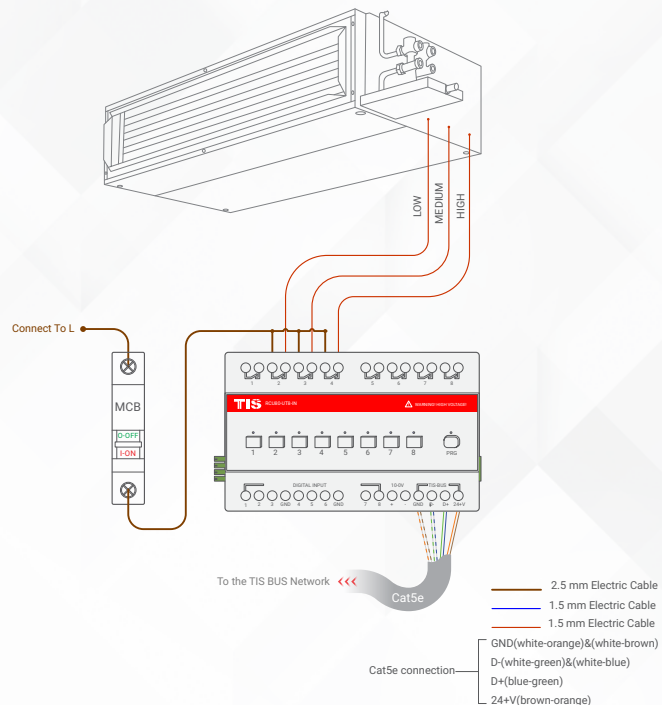

INSTALLATION STEPS

5 Connect the live (supply) wire to inputs. All inputs must have an appropriate voltage source and an MCB to protect that load circuit.

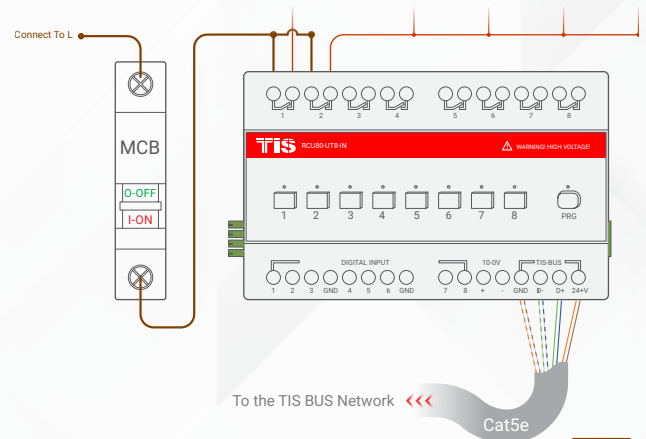

6 For channel 8, you can connect 0-10V output to any 0-10v ballast driver to simulate it.

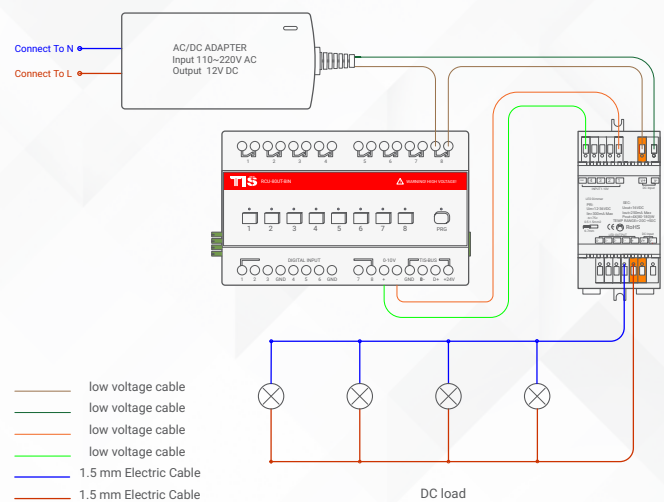

INSTALLATION STEPS

7 Connect digital inputs (dry contacts) GND terminal, and zone number (Z1-Z8) terminal to mechanical switches without any voltage supply. Then test it by pressing the wall switch up/down, Z1-Z8 inputs will trigger relay ch1-ch8 consecutively as default setting.

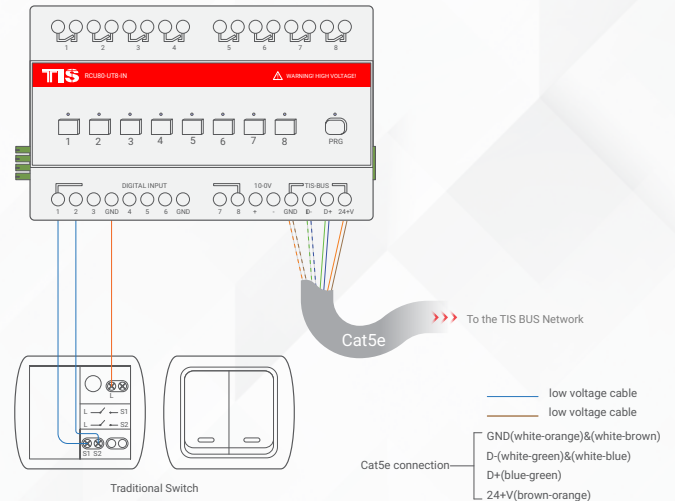

8 Turn on the power source, and then test the loads by short pressing on the device's local override buttons 1-8.

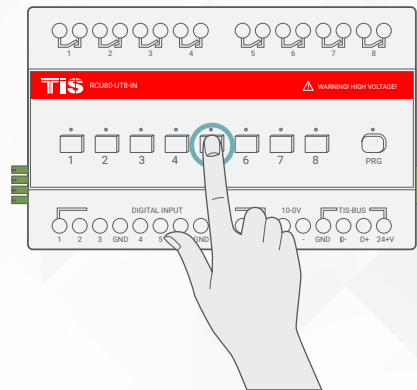

PAIRING (MANUAL PROGRAMMING)

LIGHTS / APPLIANCES PROGRAMMING

All channels by default are used for lights/appliances control.

You can pair device light channels to any wall panels by doing the following:

1 Long press on any buttons 1-8 for 6 seconds. The LED indicator for the pressed button will start blinking.

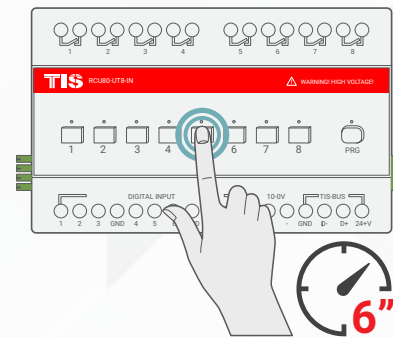

2 Short press on any wall lights buttons on the Luna, Mars, Terre or others panels.

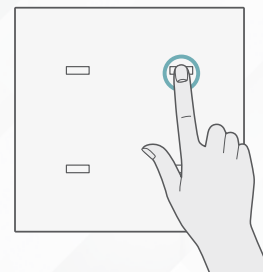

3 Test the button on the panel by short pressing it for ON/OFF.

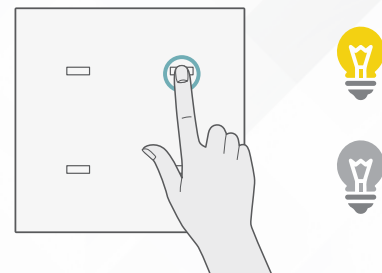

PAIRING (MANUAL PROGRAMMING)

FLOOR HEATING PROGRAMMING

1 Long press on any buttons 1-8 for 6 seconds. The LED indicator for the pressed button will start blinking.

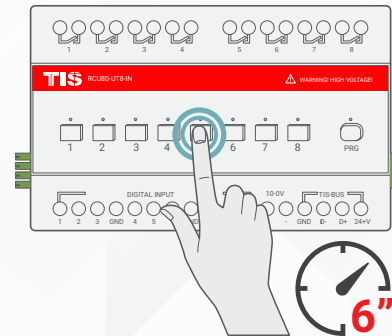

2 Go to floor heater page on any wall panel with the floor heating function, and press ON button to turn on the floor heating.

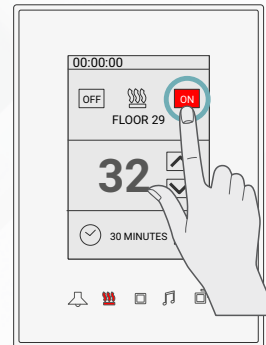

3 Test the floor heating by changing the temperature and turning it OFF/ON.

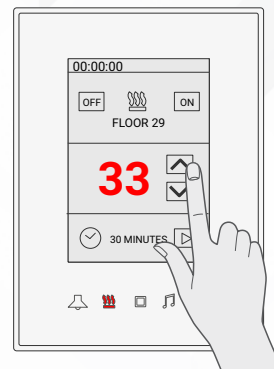

PAIRING (MANUAL PROGRAMMING)

SHUTTER COMBINATION PROGRAMMING

You can change any 2 channels in sequence like CH1 and CH2, Ch3 and CH4... , CH7 and CH8 to be combined (interlocked) together to work as shutter/curtain control.

To combine these 2 channels, complete the following steps manually:

1 Press the PRG button for 3 seconds until the LED starts blinking rapidly.

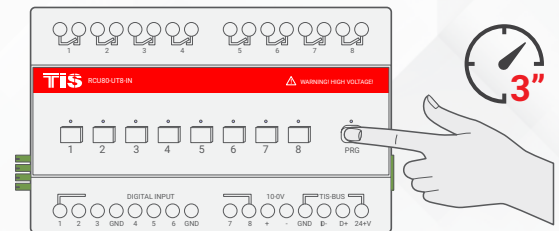

2 Short press on the first button and then the second button that you want to combine as curtain control; for example, CH3 and CH4.

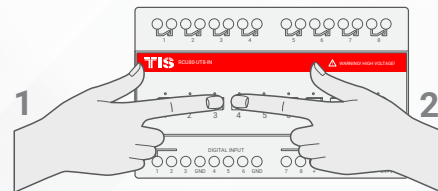

3 Wait for few seconds until the PRG LED stops blinking.

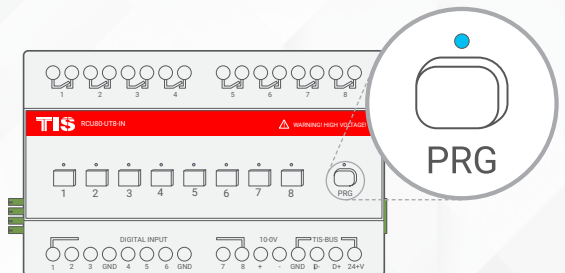

4 Test by turning the first button ON and then the second button. Both buttons should not turn ON together. If you see that the first button is turning the other button off, that means that your buttons are successfully combined as shutter/curtain mode.

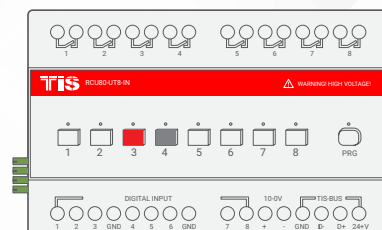

PAIRING (MANUAL PROGRAMMING)

5» To program the curtain to any wall panel, press and hold the CH (Shutter-Open) button for 6 seconds. The LED indicator of the pressed button will start blinking,

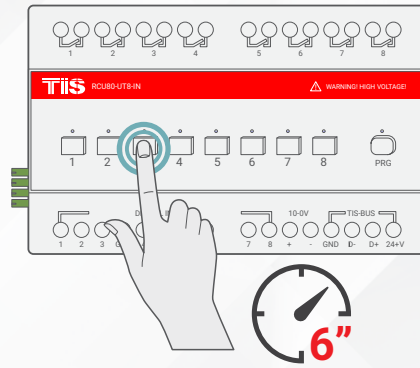

6» Short press on any button on the Luna, Mars, Terre or others wall panels.

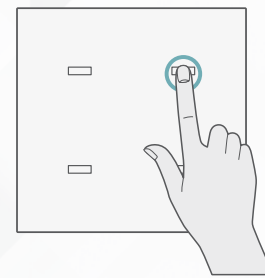

7» Test the button on the panel by short pressing for open/stop. Do the same to program the Close channel with another button.

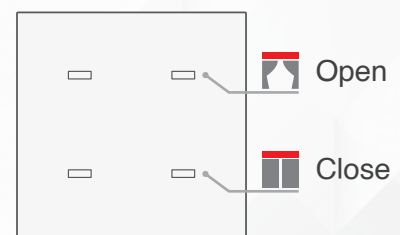

8» To cancel the curtain interlock and return to lighting mode, repeat steps 1-3 above.

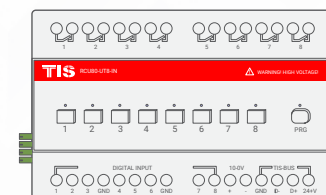

PAIRING (MANUAL PROGRAMMING)

FCU COMBINATION PROGRAMMING

You can change any 3 channels in sequence like CH1-3, and CH4-6, to be combined (interlocked) together to work as FCU (Low, Medium, High).

To combine these 3 channels complete the following steps manually:

1 Press the PRG button for 3 seconds until the LED starts blinking rapidly.

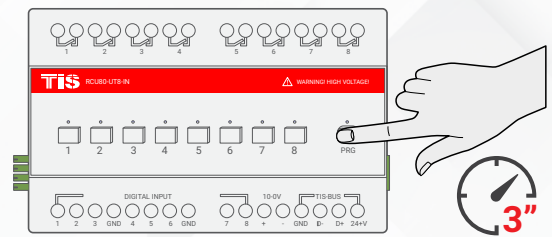

2 Short press on the first button, then the second button, and then the third button that you want to combine as FCU; for example, CH4-6.

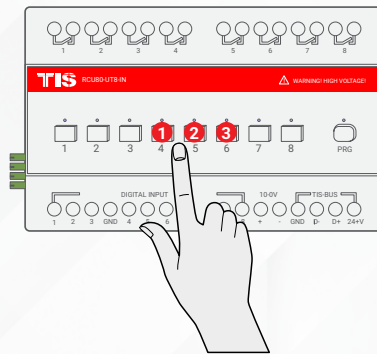

3 Wait for a few seconds until the PRG LED stops blinking.

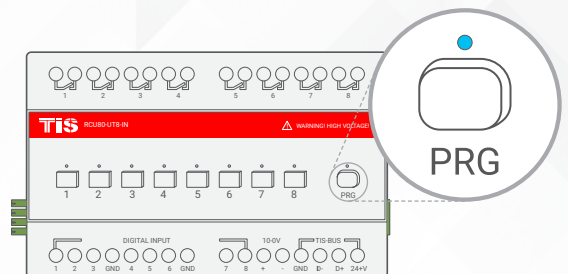

PAIRING (MANUAL PROGRAMMING)

4» Test by turning the first button ON, then the second button, and then the third button. The buttons should not turn ON together. If you see that any button you turned ON is turning the other 2 buttons OFF, that means your buttons are successfully combined as FCU mode.

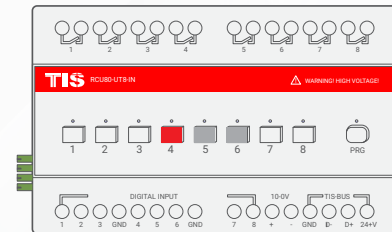

5» To program the FCU to any wall thermostat panel, press and hold the first Channel L (LOW) button for 6 seconds. The LED indicator of the pressed button will start blinking,

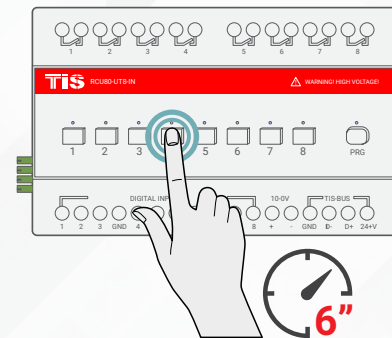

6» Go to the air conditioning page in your Luna TFT, Mars AC, Terre AC, or other thermostat panel, and turn the AC ON.

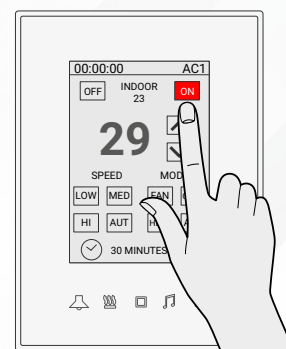

PAIRING (MANUAL PROGRAMMING)

7 Test your air conditioning by changing the fan speed from low to medium to high. Your relay should respond accordingly.

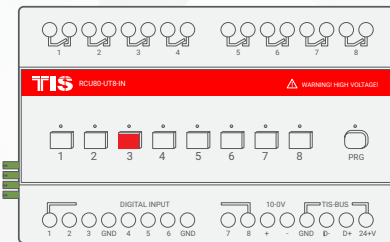
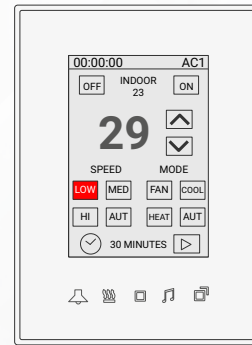

8 To cancel the FCU interlock and return back to lighting mode, repeat steps 1-3 above.

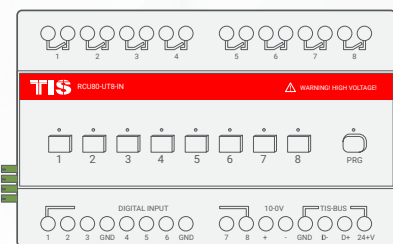



TROUBLESHOOTING



PRG Button Blinks Red Color Rapidly

Reason: The Module address conflicts with other device in TIS network, you need to press and hold the PRG button for 6 seconds so the module can get new address



Device PRG LED is not Blinking; Device not Powered

Reason: Device is not powered on; no TIS-BUS 24V supply connected to the device.



Device Button LED ON but lights not ON

Reason 1: Lights' neutral wire not connected

Reason 2: Channel protection delay time is enabled in software.



Wall Panels can't Pair with the Device

Reason 1: TIS-BUS connection has a problem; check the wires and make sure there's not a short in the connection.

Reason 2: Manual programming function disabled in the device (default is enabled).



Wall Panels can't Control the Device Channels

Reason 1: TIS-BUS connection has a problem; check the wires and make sure there's not a short in the connection.

Reason 2: Programming address is wrong.



Dry input is not turning the RCU lights ON/OFF

Reason: Either the default setting in software or the RCU address has changed.



Channel is turning off by itself after few seconds

Reason: It is programmed as shutter / curtain combination, and running time is enabled in the software.