

▲ Figure 1: Lights Connection Diagram

ROOM CONTROL UNIT

20 INPUTS 20 OUTPUTS WITH IP PORT

Model: RCU-20R20Z-IP

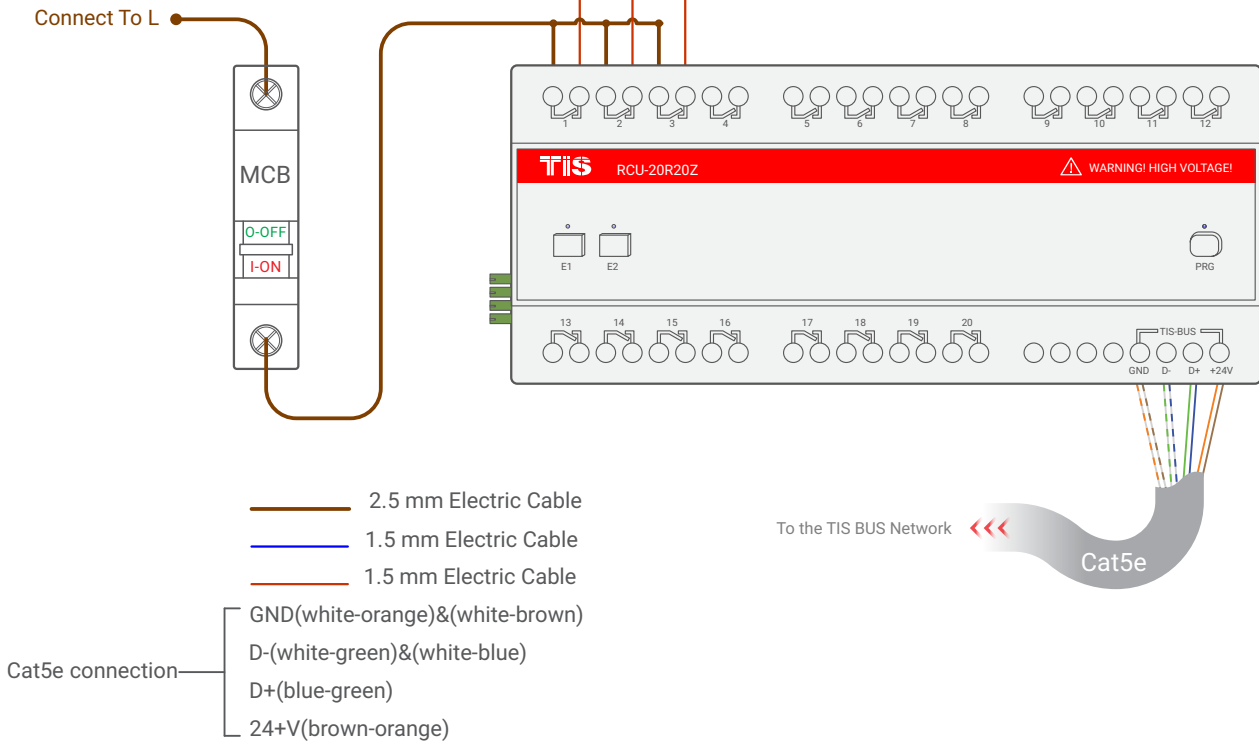
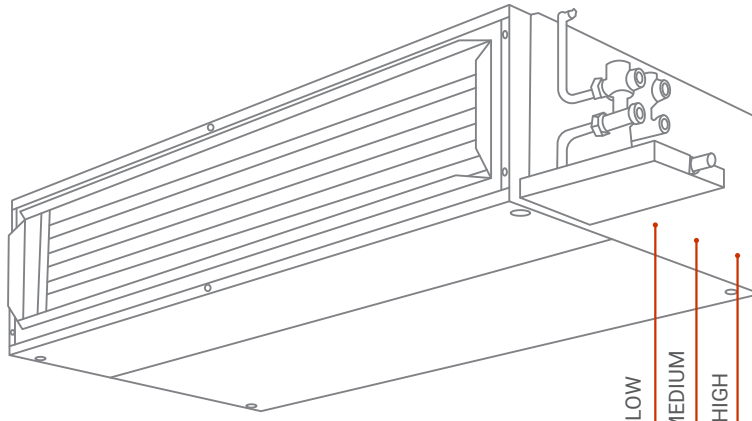

▲ Figure 2: FCU Connection Diagram



Copyright © 2020 TIS, All Rights Reserved
 TIS Logo is a Registered Trademark of Texas Intelligent System LLC in the United States of America. This company takes TIS Control Ltd. in other countries. All of the Specifications are subject to change without notice.

TEXAS INTELLIGENT SYSTEM LLC
 SUITE# 610, 860 NORTH DOROTHY DR
 RICHARDSON
 TX 75081.USA

TIS CONTROL LIMITED
 RM 1502-p9 Easey CommBldg
 253-261 Hennessy Rd Wanchai
 Hong Kong

ROOM CONTROL UNIT

20 INPUTS 20 OUTPUTS WITH IP PORT

Model: RCU-20R20Z-IP

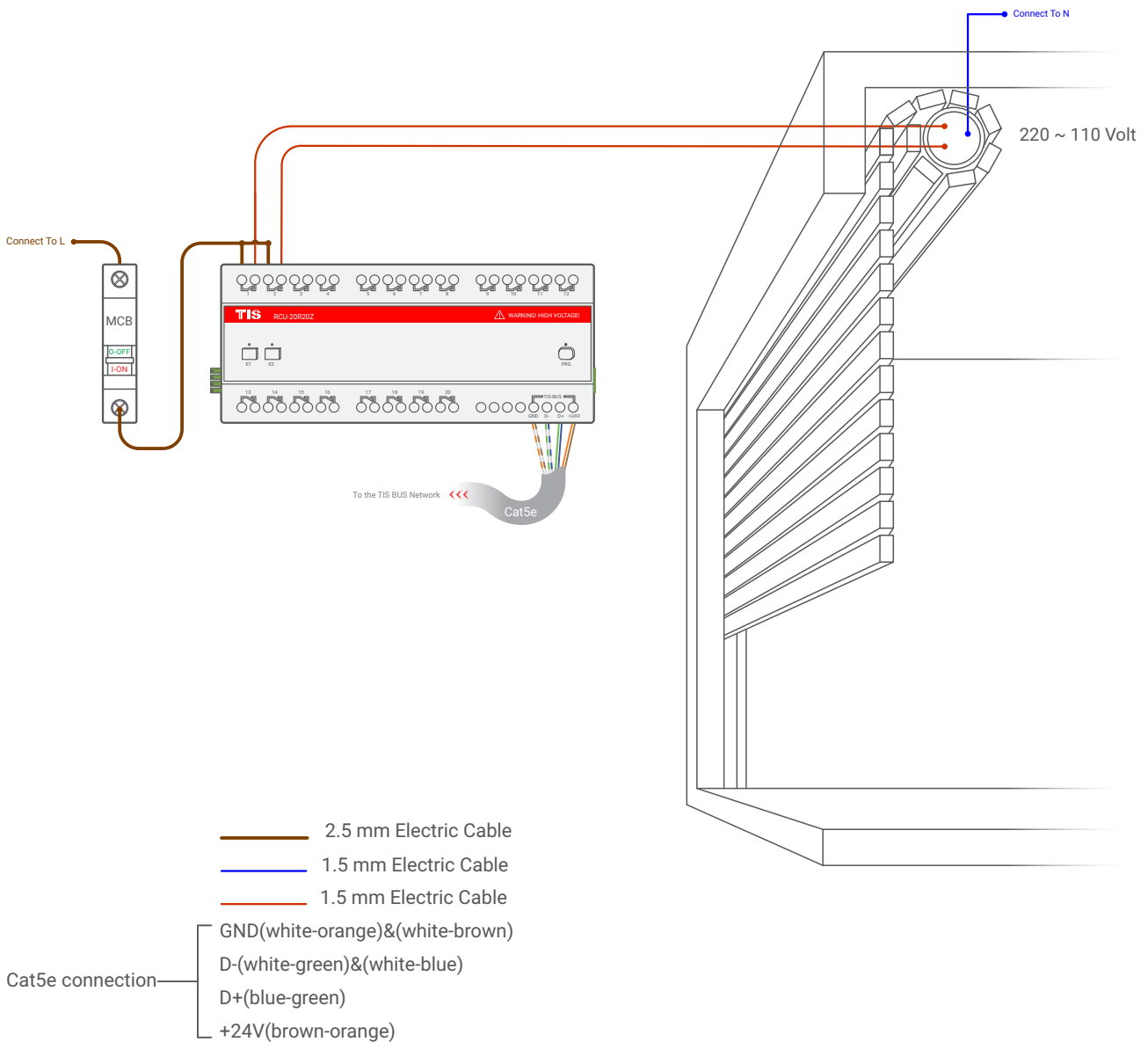

▲ Figure 3: Motors Connection Diagram



Copyright © 2020 TIS, All Rights Reserved
 TIS Logo is a Registered Trademark of Texas Intelligent System LLC in the United States of America. This company takes TIS Control Ltd. in other countries. All of the Specifications are subject to change without notice.

TEXAS INTELLIGENT SYSTEM LLC
 SUITE# 610, 860 NORTH DOROTHY DR
 RICHARDSON
 TX 75081.USA

TIS CONTROL LIMITED
 RM 1502-p9 Easey CommBldg
 253-261 Hennessy Rd Wanchai
 Hong Kong

ROOM CONTROL UNIT

20 INPUTS 20 OUTPUTS WITH IP PORT

Model: RCU-20R20Z-IP

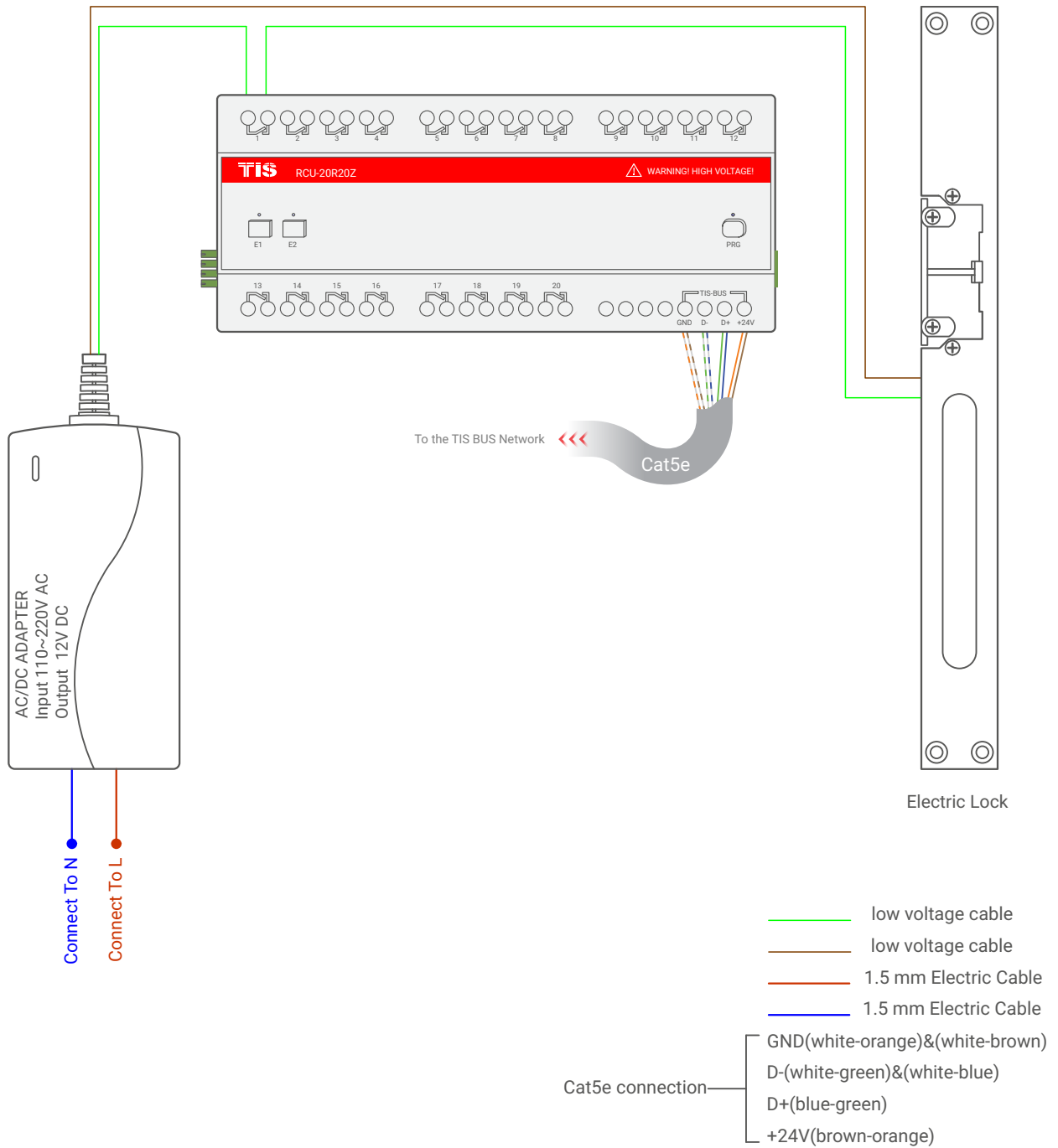

▲ Figure 4: Electric Lock Connection Diagram



Copyright © 2020 TIS, All Rights Reserved
TIS Logo is a Registered Trademark of Texas Intelligent System LLC in the United States of America. This company takes TIS Control Ltd. in other countries. All of the Specifications are subject to change without notice.

TEXAS INTELLIGENT SYSTEM LLC
SUITE# 610, 860 NORTH DOROTHY DR
RICHARDSON
TX 75081.USA

TIS CONTROL LIMITED
RM 1502-p9 Easey CommBldg
253-261 Hennessy Rd Wanchai
Hong Kong

ROOM CONTROL UNIT

20 INPUTS 20 OUTPUTS WITH IP PORT

Model: RCU-20R20Z-IP

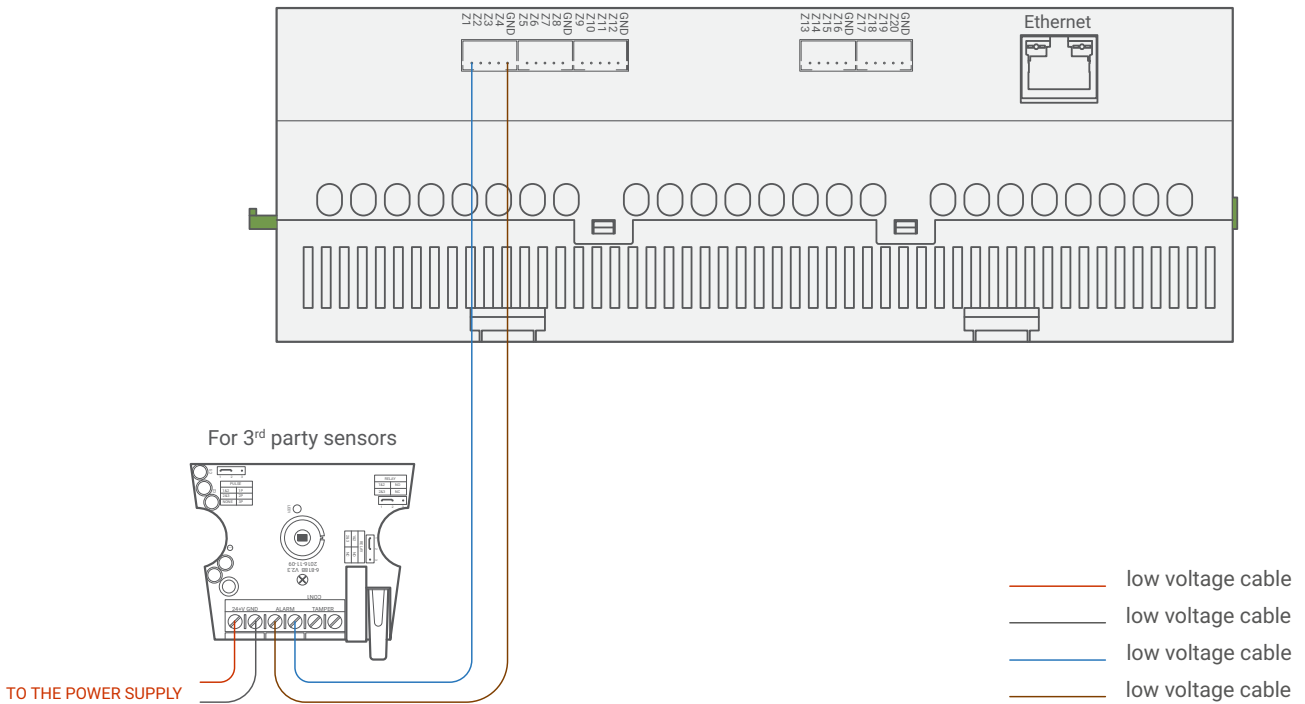

▲ Figure 5: 3rd Party Sensor Connection Diagram



Copyright © 2020 TIS, All Rights Reserved
TIS Logo is a Registered Trademark of Texas Intelligent System LLC in the United States of America. This company takes TIS Control Ltd. in other countries. All of the Specifications are subject to change without notice.

TEXAS INTELLIGENT SYSTEM LLC
SUITE# 610, 860 NORTH DOROTHY DR
RICHARDSON
TX 75081.USA

TIS CONTROL LIMITED
RM 1502-p9 Easey CommBldg
253-261 Hennessy Rd Wanchai
Hong Kong

ROOM CONTROL UNIT

20 INPUTS 20 OUTPUTS WITH IP PORT

Model: RCU-20R20Z-IP

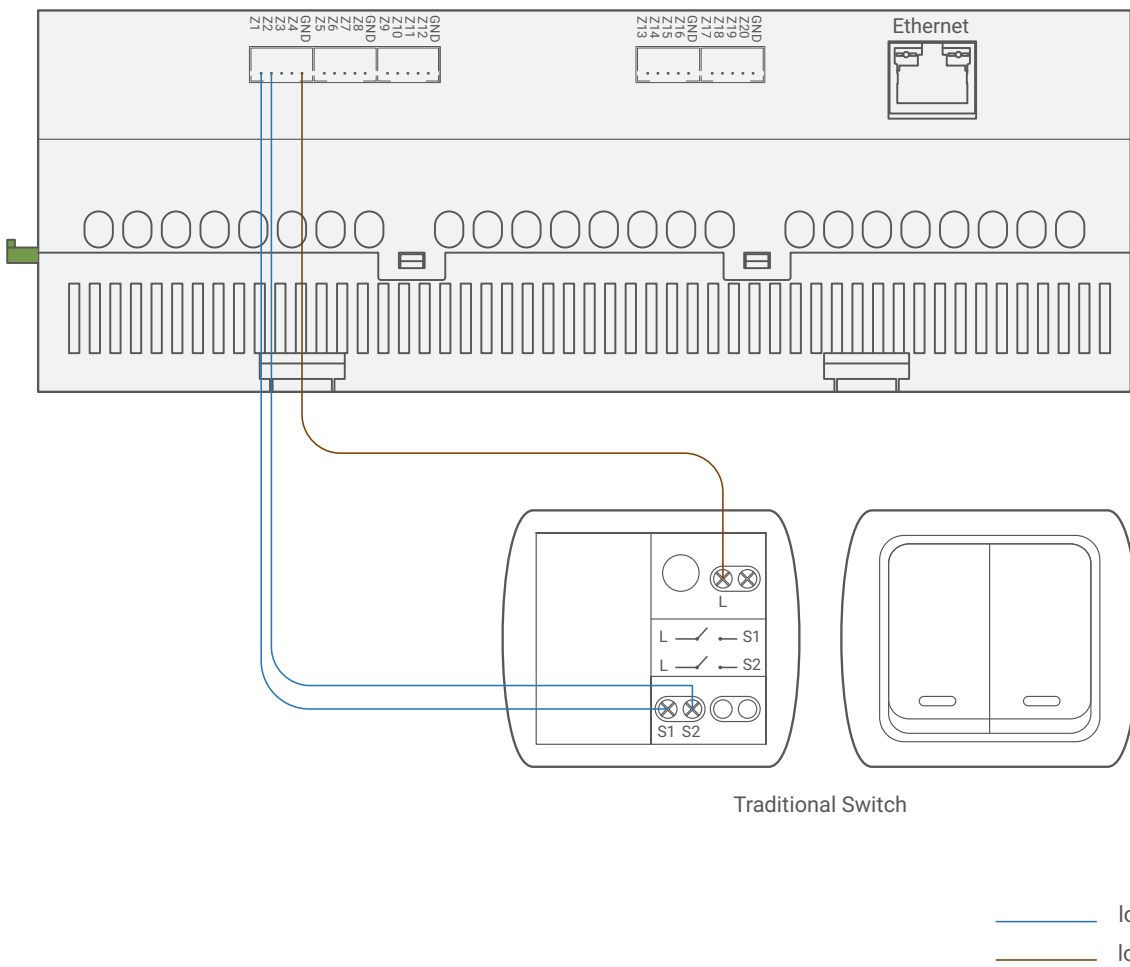

▲ Figure 6: Traditional Light Switch Connection Diagram



Copyright © 2020 TIS, All Rights Reserved
 TIS Logo is a Registered Trademark of Texas Intelligent System LLC in the United States of America. This company takes TIS Control Ltd. in other countries. All of the Specifications are subject to change without notice.

TEXAS INTELLIGENT SYSTEM LLC
 SUITE# 610, 860 NORTH DOROTHY DR
 RICHARDSON
 TX 75081.USA

TIS CONTROL LIMITED
 RM 1502-p9 Easey CommBldg
 253-261 Hennessy Rd Wanchai
 Hong Kong

ROOM CONTROL UNIT

20 INPUTS 20 OUTPUTS WITH IP PORT

Model: RCU-20R20Z-IP

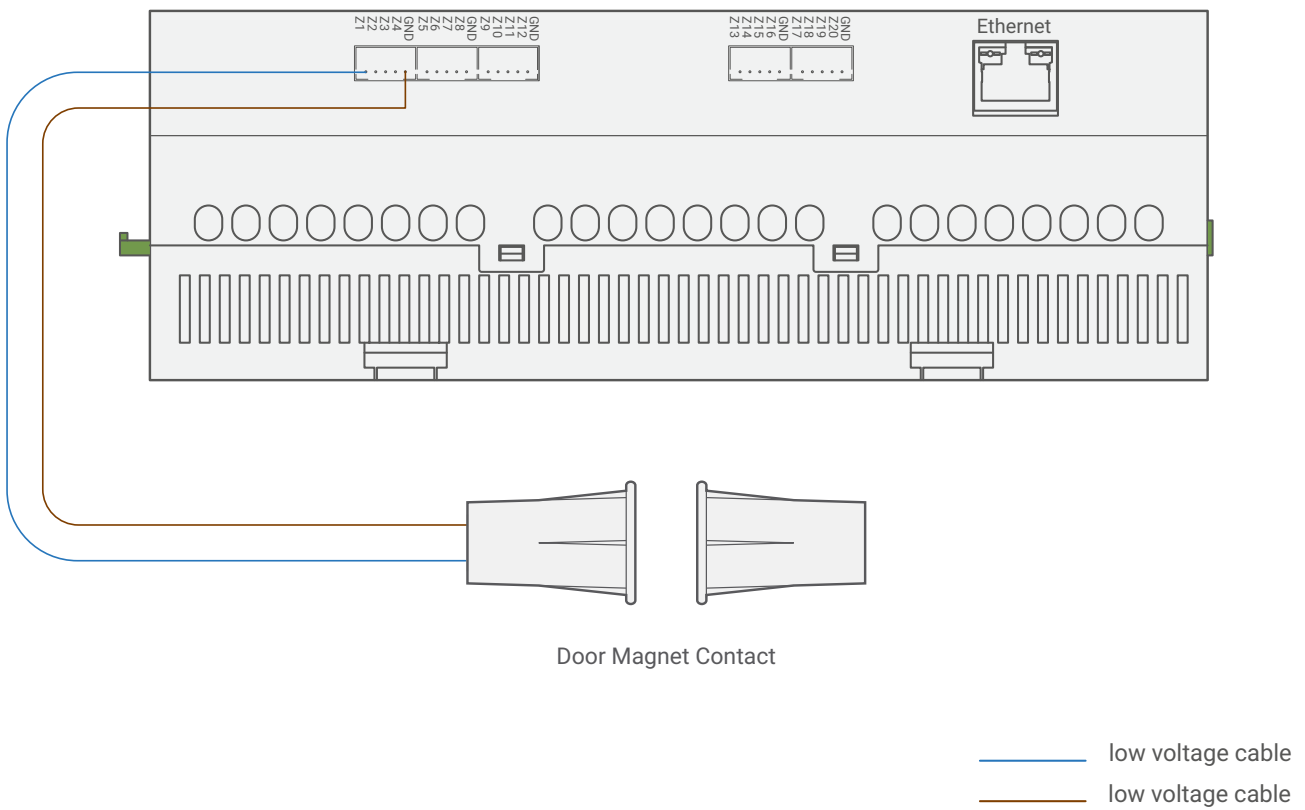

▲ Figure 7: Magnetic Door Contact Connection Diagram



Copyright © 2020 TIS, All Rights Reserved
TIS Logo is a Registered Trademark of Texas Intelligent System LLC in the United States of America. This company takes TIS Control Ltd. in other countries. All of the Specifications are subject to change without notice.

TEXAS INTELLIGENT SYSTEM LLC
SUITE# 610, 860 NORTH DOROTHY DR
RICHARDSON
TX 75081.USA

TIS CONTROL LIMITED
RM 1502-p9 Easay CommBldg
253-261 Hennessy Rd Wanchai
Hong Kong

ROOM CONTROL UNIT

20 INPUTS 20 OUTPUTS WITH IP PORT

Model: RCU-20R20Z-IP

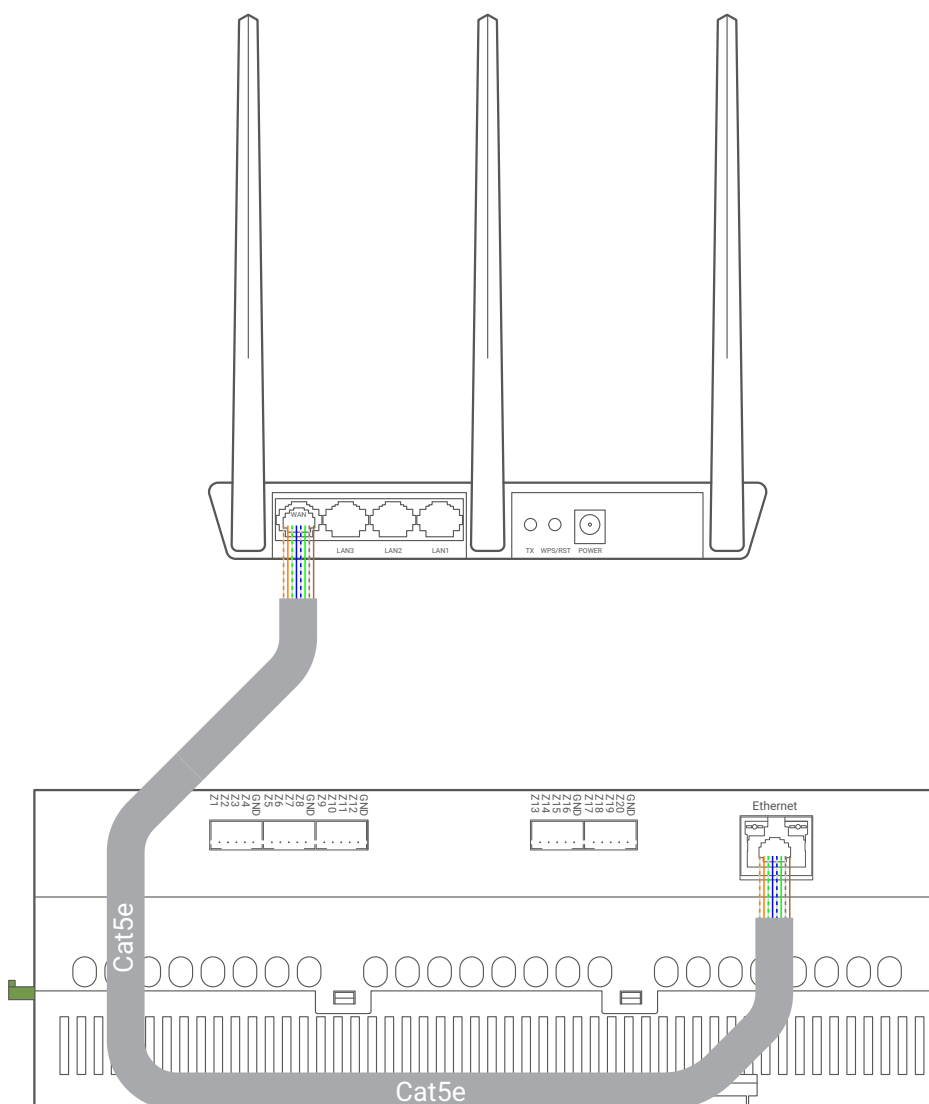

▲ Figure 8: Ethernet Router Connection Diagram



Copyright © 2020 TIS, All Rights Reserved
TIS Logo is a Registered Trademark of Texas Intelligent System LLC in the United States of America. This company takes TIS Control Ltd. in other countries. All of the Specifications are subject to change without notice.

TEXAS INTELLIGENT SYSTEM LLC
SUITE# 610, 860 NORTH DOROTHY DR
RICHARDSON
TX 75081.USA

TIS CONTROL LIMITED
RM 1502-p9 Eassey CommBldg
253-261 Hennessy Rd Wanchai
Hong Kong

ROOM CONTROL UNIT

20 INPUTS 20 OUTPUTS WITH IP PORT

Model: RCU-20R20Z-IP

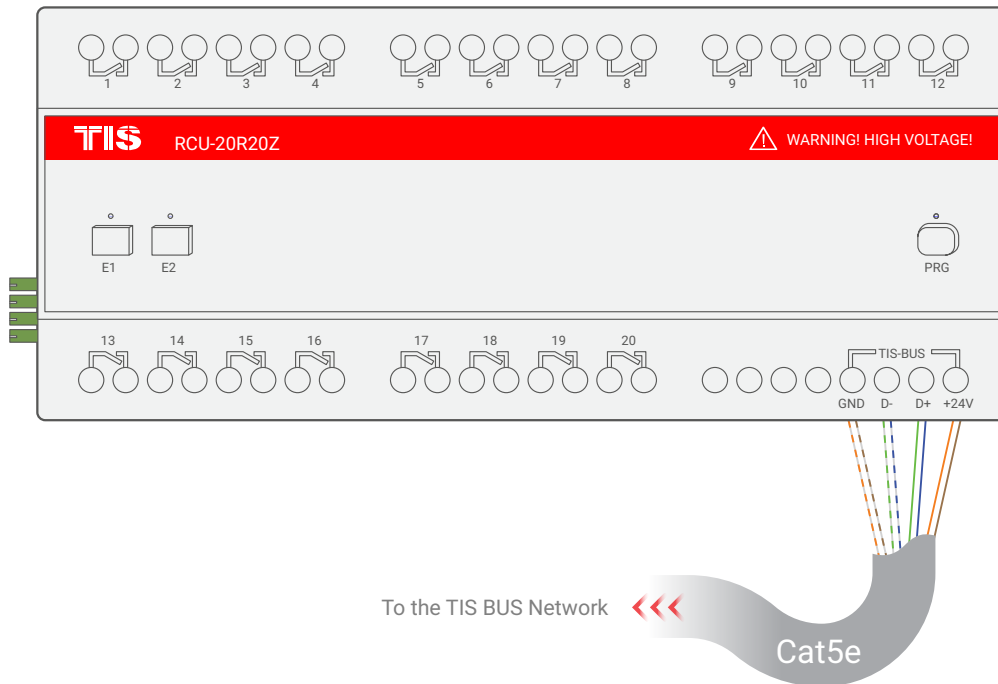

- Cat5e connection
- GND(white-orange)&(white-brown)
 - D-(white-green)&(white-blue)
 - D+(blue-green)
 - +24V(brown-orange)

▲ Figure 9: Module's Bus Connection Color Coding



Copyright © 2020 TIS, All Rights Reserved
 TIS Logo is a Registered Trademark of Texas Intelligent System LLC in the United States of America. This company takes TIS Control Ltd. in other countries. All of the Specifications are subject to change without notice.

TEXAS INTELLIGENT SYSTEM LLC
 SUITE# 610, 860 NORTH DOROTHY DR
 RICHARDSON
 TX 75081.USA

TIS CONTROL LIMITED
 RM 1502-p9 Easey CommBldg
 253-261 Hennessy Rd Wanchai
 Hong Kong

ROOM CONTROL UNIT

20 INPUTS 20 OUTPUTS WITH IP PORT

Model: RCU-20R20Z-IP

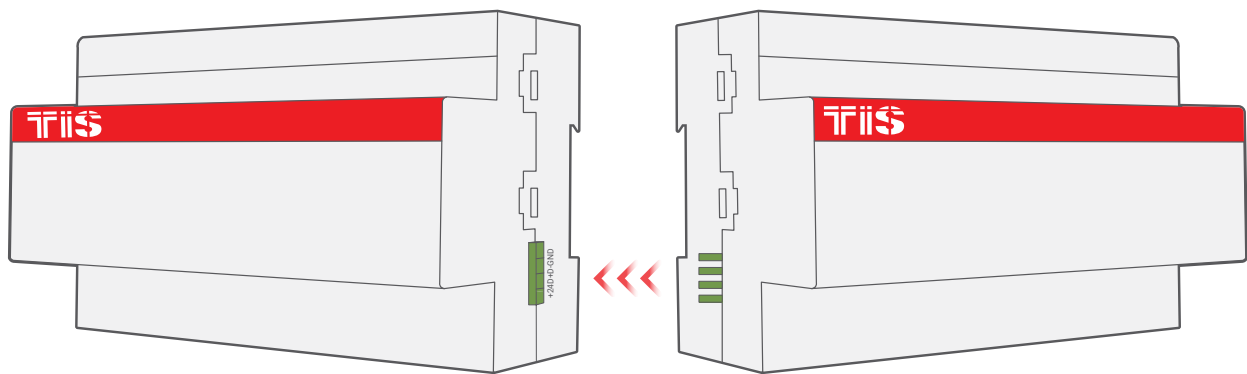

▲ Figure 10: DIN-Rail Bus Module Configuration Diagram



Copyright © 2020 TIS, All Rights Reserved
TIS Logo is a Registered Trademark of Texas Intelligent System LLC in the United States of America. This company takes TIS Control Ltd. in other countries. All of the Specifications are subject to change without notice.

TEXAS INTELLIGENT SYSTEM LLC
SUITE# 610, 860 NORTH DOROTHY DR
RICHARDSON
TX 75081.USA

TIS CONTROL LIMITED
RM 1502-p9 Eassey CommBldg
253-261 Hennessy Rd Wanchai
Hong Kong

ROOM CONTROL UNIT

20 INPUTS 20 OUTPUTS WITH IP PORT

Model: RCU-20R20Z-IP

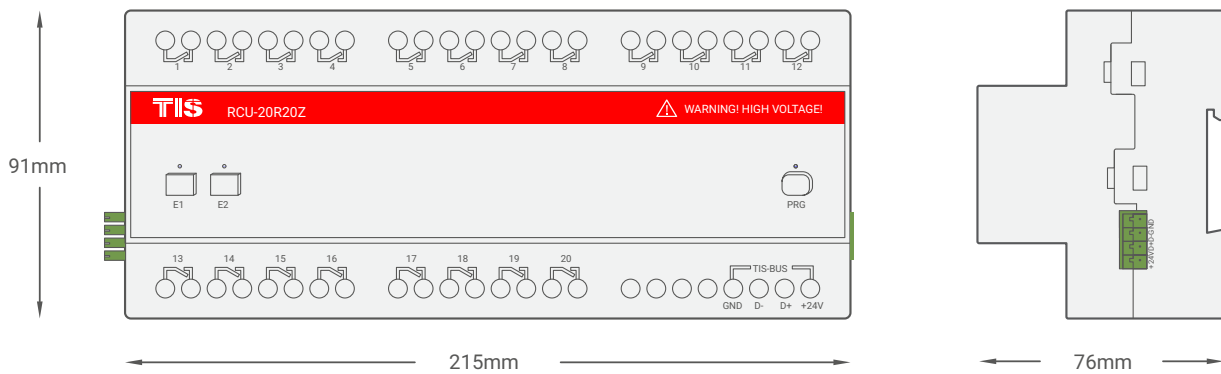

▲ Figure 11: Module's Dimension Diagram



Copyright © 2020 TIS, All Rights Reserved
TIS Logo is a Registered Trademark of Texas Intelligent System LLC in the United States of America. This company takes TIS Control Ltd. in other countries. All of the Specifications are subject to change without notice.

TEXAS INTELLIGENT SYSTEM LLC
SUITE# 610, 860 NORTH DOROTHY DR
RICHARDSON
TX 75081.USA

TIS CONTROL LIMITED
RM 1502-p9 Easey CommBldg
253-261 Hennessy Rd Wanchai
Hong Kong